

名称	スタンダードタイプ 40形 直付トラフ85幅 Hf32形高出力1灯相当 5,000K	
型番	EM9B1208T-N1E50-xxx-1	
光源	型番	-
	全光束	- [lm] -
保守率 (40,000h)	良い	0.88
	普通	0.86
	悪い	0.81
効率	上半球	1.4 [%]
	下半球	98.6 [%]
	全方向	100.0 [%]
器具光束		3,620 [lm]

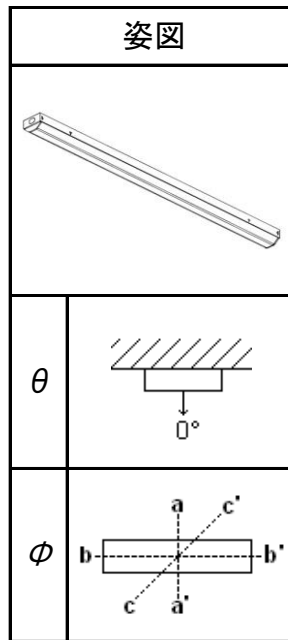

◎配光特性 [cd/1,000lm]

θ	ϕ	a-a'	b-b'	c-c'
0°		308	308	308
10°		303	302	303
20°		288	285	286
30°		264	258	261
40°		232	223	227
50°		196	181	187
60°		160	133	145
70°		119	82	103
80°		79	31	62
90°		48	0	32
100°		33	0	18
110°		19	0	7
120°		7	0	0
130°		0	0	0
140°		0	0	0
150°		0	0	0
160°		0	0	0
170°		0	0	0
180°		0	0	0

照明率表

反射率 (%)	天井		80						70						50				30		20	0
	壁	床	70		50		30		70		50		30		50		30		30	10	0	0
			30	10	30	10	30	10	30	10	30	10	30	10	30	10	30	10	30	10	0	0
室指数	照明率 (×0.01)																				初期値	
0.6	60	56	46	43	37	36	58	54	45	43	36	35	43	41	35	34	34	34	34	29	27	
0.8	71	65	56	53	46	44	69	63	55	52	46	44	52	50	44	43	43	42	42	37	34	
1	79	71	64	60	55	52	76	69	63	59	54	51	60	57	52	50	50	49	44	41	41	
1.25	87	77	73	67	63	59	83	75	71	66	62	58	67	63	59	57	57	55	50	48	48	
1.5	92	81	79	72	70	65	89	79	77	71	68	64	73	68	65	62	62	60	56	53	53	
2	101	87	89	80	80	73	97	85	86	78	78	72	81	75	74	70	71	68	64	61	61	
2.5	106	91	96	85	88	79	101	89	93	83	85	78	87	80	81	76	77	74	69	67	67	
3	109	94	101	88	93	83	105	92	97	86	90	82	91	83	85	80	81	77	73	71	71	
4	114	97	107	92	100	88	109	95	103	91	97	87	96	88	91	84	86	82	79	76	76	
5	117	99	111	95	105	92	112	97	107	94	102	90	99	90	95	88	89	85	82	79	79	
10	123	103	120	101	116	99	118	101	115	99	112	97	106	96	104	94	97	92	89	86	86	

配光曲線 (cd/1000[lm])

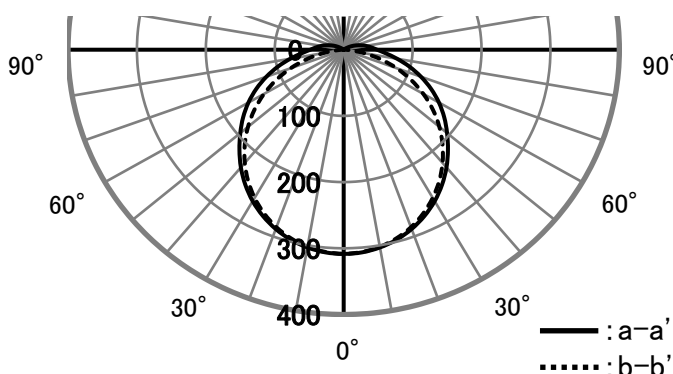

高さ(m) 直射水平面照度図 初期値

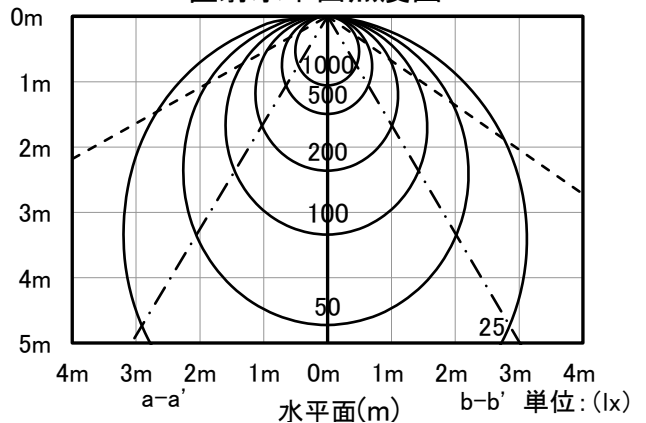

123°	1/2ビーム角---	112°
63°	1/2照度角---	62°