

名称	プレミアムタイプ 40形 埋込300幅 Hf32形定格出力2灯相当 5,000K	
型番	EM9P1230U-E2D50-xxx-1	
光源	型番	-
	全光束	- [lm] -
保守率 (40,000h)	良い	0.80
	普通	0.76
	悪い	0.68
効率	上半球	0.0 [%]
	下半球	100.0 [%]
	全方向	100.0 [%]
器具光束		4,910 [lm]

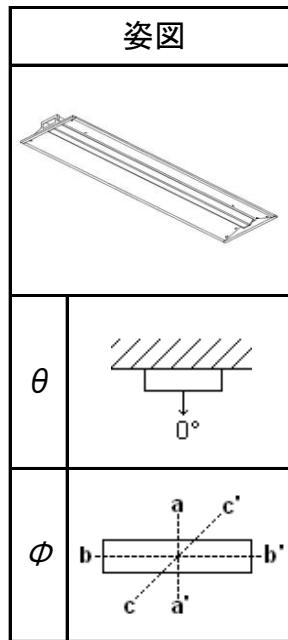

◎配光特性 [cd/1,000lm]

θ	ϕ	a-a'	b-b'	c-c'
0°		331	331	331
10°		325	324	325
20°		309	306	307
30°		283	276	280
40°		249	238	243
50°		214	192	202
60°		175	141	160
70°		123	86	110
80°		67	31	59
90°		0	0	0
100°		0	0	0
110°		0	0	0
120°		0	0	0
130°		0	0	0
140°		0	0	0
150°		0	0	0
160°		0	0	0
170°		0	0	0
180°		0	0	0

照明率表

反射率 (%)	天井 壁床	80						70						50				30		20	0
		70		50		30		70		50		30		50		30		30	10	0	
		30	10	30	10	30	10	30	10	30	10	30	10	30	10	30	10	30	10	10	0
室指数		照明率 (×0.01)																		初期値	
0.6		62	57	47	44	38	37	60	55	46	44	37	36	44	43	37	36	36	35	31	29
0.8		72	66	57	54	48	46	70	64	56	53	47	45	54	52	46	45	45	44	39	37
1		81	72	66	61	56	53	78	71	65	60	55	53	62	59	54	52	53	51	46	44
1.25		88	79	75	68	65	61	85	77	73	67	64	60	70	66	62	59	60	58	53	51
1.5		94	83	81	74	72	66	91	81	79	73	70	66	76	71	68	65	66	64	59	57
2		102	89	91	81	83	75	99	87	89	80	81	75	84	78	78	73	75	72	68	66
2.5		108	93	98	87	90	81	104	91	95	85	88	80	90	83	84	79	81	77	74	72
3		111	96	103	90	96	85	108	94	100	89	93	84	94	87	89	83	85	81	78	76
4		116	99	109	94	103	91	112	97	106	93	100	90	100	91	95	88	91	86	83	81
5		119	101	113	97	108	94	115	99	109	96	105	93	103	94	99	91	94	89	87	84
10		125	105	122	103	119	101	120	103	117	102	115	100	110	99	108	98	101	96	94	92

配光曲線 (cd/1000[lm])

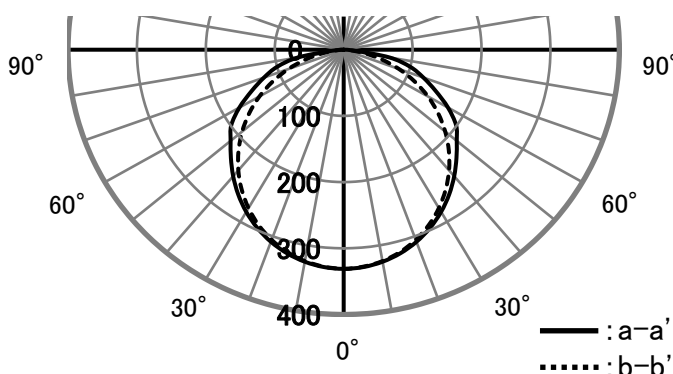

高さ(m) 直射水平面照度図 初期値

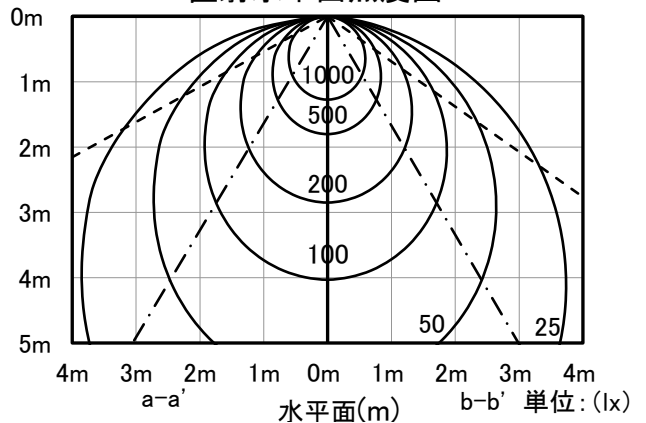

123°	1/2ビーム角 ---	111°
63°	1/2照度角 - - -	62°