

名称	スタンダードタイプ 40形 直付反射笠150幅 Hf32形定格出力2灯相当 5,000K	
型番	EM9B1215R-E2E50-xxx-1	
光源	型番	-
	全光束	- [lm] -
保守率 (40,000h)	良い	0.86
	普通	0.81
	悪い	0.72
効率	上半球	0.0 [%]
	下半球	100.0 [%]
	全方向	100.0 [%]
器具光束		5,000 [lm]

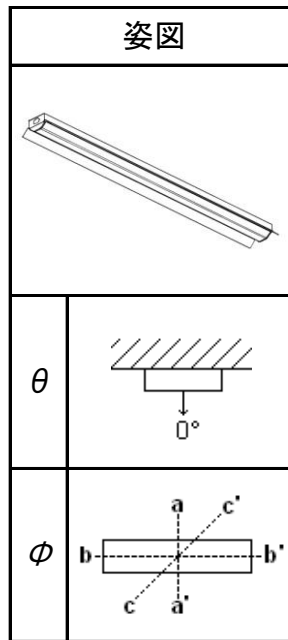

◎配光特性 [cd/1,000lm]

θ	ϕ	a-a'	b-b'	c-c'
0°		338	338	338
10°		333	332	332
20°		318	313	314
30°		291	284	284
40°		256	246	247
50°		217	200	203
60°		173	149	156
70°		117	93	106
80°		46	37	44
90°		0	0	0
100°		0	0	0
110°		0	0	0
120°		0	0	0
130°		0	0	0
140°		0	0	0
150°		0	0	0
160°		0	0	0
170°		0	0	0
180°		0	0	0

照明率表

反射率 (%)	天井		80						70						50				30		20	0
	壁	床	70		50		30		70		50		30		50		30		30	10	0	
			30	10	30	10	30	10	30	10	30	10	30	10	30	10	30	10	30	10	10	0
室指数	照明率 (×0.01)																				初期値	
0.6	62	57	47	45	38	37	60	56	46	44	38	37	45	43	37	37	37	36	31	29		
0.8	73	66	58	54	48	46	71	65	57	54	48	46	55	52	47	45	46	45	40	38		
1	81	73	67	62	57	54	79	71	65	61	56	54	63	60	55	53	53	52	47	45		
1.25	89	79	75	69	66	62	86	77	74	68	65	61	70	66	63	60	61	59	54	52		
1.5	95	83	82	74	73	67	92	82	80	73	71	67	76	71	69	66	67	64	60	58		
2	103	90	92	82	83	76	99	88	90	81	82	75	85	79	79	74	76	73	69	67		
2.5	108	93	99	87	91	82	105	92	96	86	89	81	91	84	85	80	82	78	75	73		
3	112	96	104	91	97	86	108	95	101	90	94	85	95	87	90	84	86	82	79	77		
4	117	99	110	95	104	91	112	98	106	94	101	90	100	92	96	89	91	87	84	82		
5	120	101	114	98	109	94	115	100	110	97	106	94	103	94	100	92	95	90	87	85		
10	126	105	122	103	119	101	121	104	118	102	115	100	110	100	108	98	102	96	94	92		

配光曲線 (cd/1000[lm])

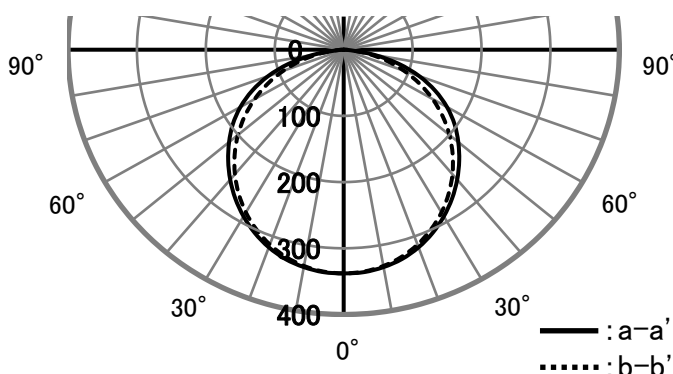

高さ(m) 直射水平面照度図 初期値

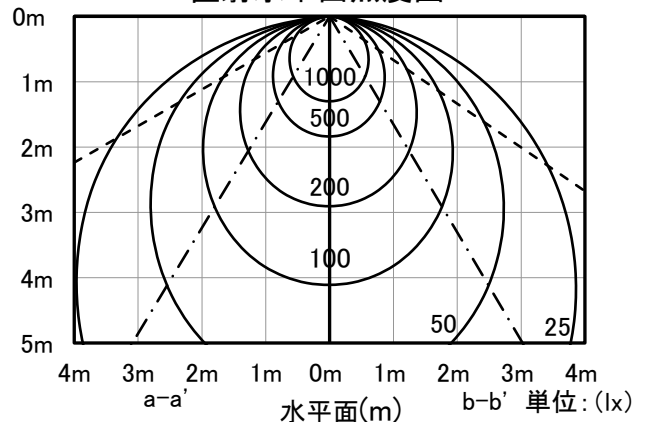

122°	1/2ビーム角---	112°
63°	1/2照度角- - -	62°