

名称	EM11 40形 W120 屋白色 6,900lmタイプ ハイグレード	
型番	EM11SA-B4N69HF9-A	
光源	型番	-
	全光束	- [lm] -
保守率 (40,000h)	良い	0.88
	普通	0.86
	悪い	0.81
効率	上半球	1.3 [%]
	下半球	98.7 [%]
	全方向	100.0 [%]
器具光束	6,900 [lm]	

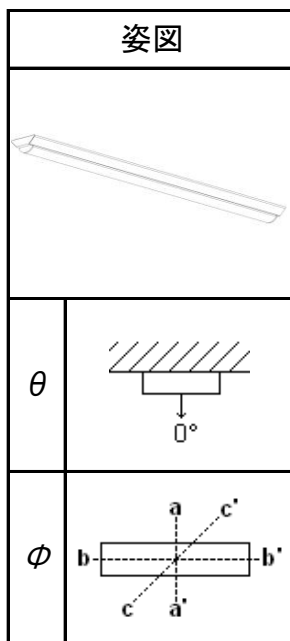

◎配光特性 [cd/1,000lm]

θ	ϕ	a-a'	b-b'	c-c'
0°		303	303	303
10°		297	295	296
20°		284	281	283
30°		262	255	258
40°		232	217	225
50°		196	171	185
60°		158	122	143
70°		120	77	102
80°		86	39	66
90°		57	12	38
100°		35	0	19
110°		20	0	0
120°		11	0	0
130°		0	0	0
140°		0	0	0
150°		0	0	0
160°		0	0	0
170°		0	0	0
180°		0	0	0

照明率表

反射率 (%)	天井		80						70						50				30		20	0
	壁	床	70		50		30		70		50		30		50		30		30	10	10	0
			30	10	30	10	30	10	30	10	30	10	30	10	30	10	30	10	30	10	10	0
室指数	照明率 (×0.01) 初期値																					
0.6	60	56	45	43	36	35	58	54	44	42	36	35	43	41	35	34	34	33	29	27		
0.8	71	64	56	52	46	44	68	63	54	51	45	43	52	49	44	42	42	41	36	34		
1	79	71	64	60	54	51	76	69	62	58	53	51	59	56	51	49	49	48	43	41		
1.25	86	77	72	66	62	59	83	75	70	65	61	58	66	63	59	56	56	55	50	47		
1.5	92	81	79	71	69	64	88	79	76	70	67	63	72	67	64	61	62	60	55	52		
2	100	87	89	79	80	72	96	85	86	78	77	71	80	75	74	69	70	67	63	60		
2.5	105	91	95	84	87	78	101	89	92	82	84	77	86	79	80	75	76	73	68	66		
3	109	93	100	88	92	82	104	91	96	86	90	81	90	83	85	79	80	76	73	70		
4	114	97	106	92	100	88	109	95	102	90	96	86	95	87	90	84	85	81	78	75		
5	117	99	110	95	105	91	112	97	106	93	101	89	98	90	94	87	89	84	81	78		
10	123	103	119	100	116	98	118	101	114	99	111	97	106	96	103	94	96	91	88	85		

配光曲線 (cd/1000[lm])

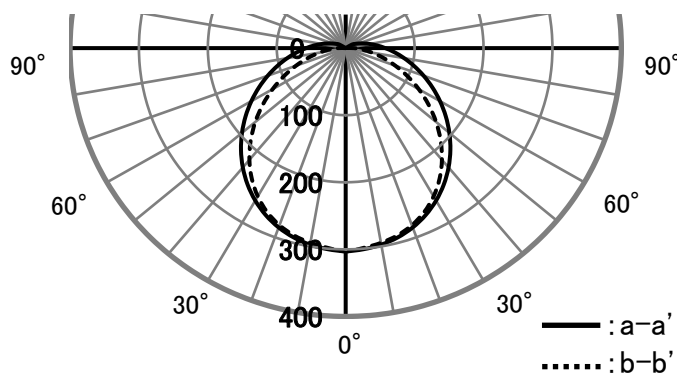

高さ(m) 直射水平面照度図 初期値

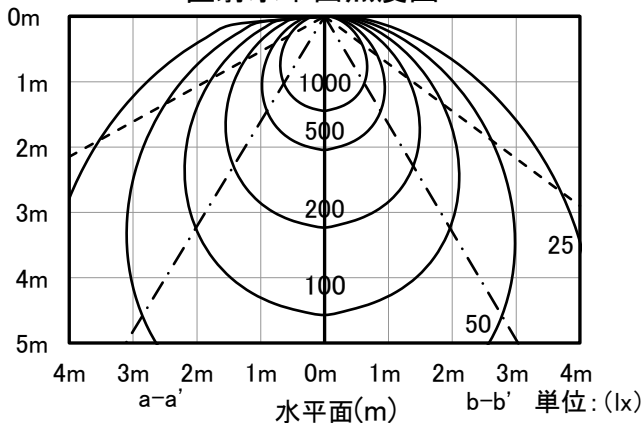

124°	1/2ビーム角---	108°
64°	1/2照度角---	62°